

### Common Alarm Annunciator RP 5990, RP 5991

- Fast localisation of failures and their causes
- Reduction of standstill times in production
- Common alarm annunciator with manual or auto reset of faults
- Expandable from 8 to 88 fault signals
- Open or closed circuit operation settable with rotational switch on base unit and with link X1/X2 on extension units
- Adjustable on delay for input signals 0 to 10 sec
- Reset buttons for audible alarm and common alarm on front side
- Connection for external reset of audible alarm
- Galvanic separation to bus RS485 (optional)
- Accessories: buzzer RK 8832, display unit EH 5990, EH 5991
- Width: 70 mm

### • Base Module RP 5990:

- 8 fault signal inputs with indicator LED on the unit
- One relay output each for audible alarm and common alarm
- Reset buttons for audible alarm and common alarm
- Connection for external reset of audible alarm

### • Extension Module RP 5991:

- 8 fault signal inputs with indicator LED on the unit
- As option one relay output each for audible alarm and common alarm
- As option reset buttons for audible alarm and common alarm

### Display Unit EH 5990, EH 5991

- Exchangable front label for individual legending
- As option galvanic separated RS458 bus
- Protection degree for front side IP64
- Enclosure for flush mounting 96 x 96 mm

### • Display Unit EH 5990:

- 8 fault signal LEDs on the unit
- Reset buttons for audible alarm and common alarm

### • Display Unit EH 5991:

- 8 fault signal LEDs on the unit
- Without reset buttons

### Circuit Diagrams

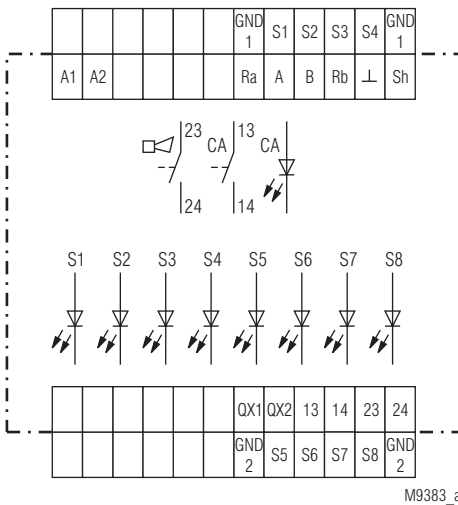

M9383\_a

### RP 5990

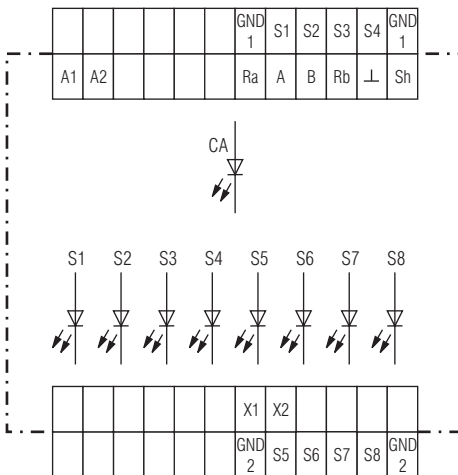

M9384\_a

### RP 5991

### Additional Information about this topic

General Information for INFOMASTER B see data sheet INFOMASTER B, Systemoverview

### Approvals and Marking



### Circuit Diagram

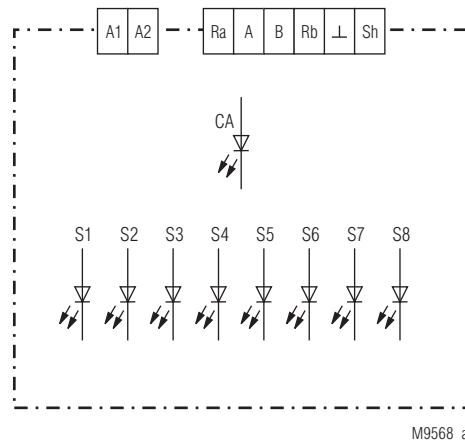

M9568\_a

### EH 5990, EH 5991

## Function Diagram (Faults with Manual Reset)

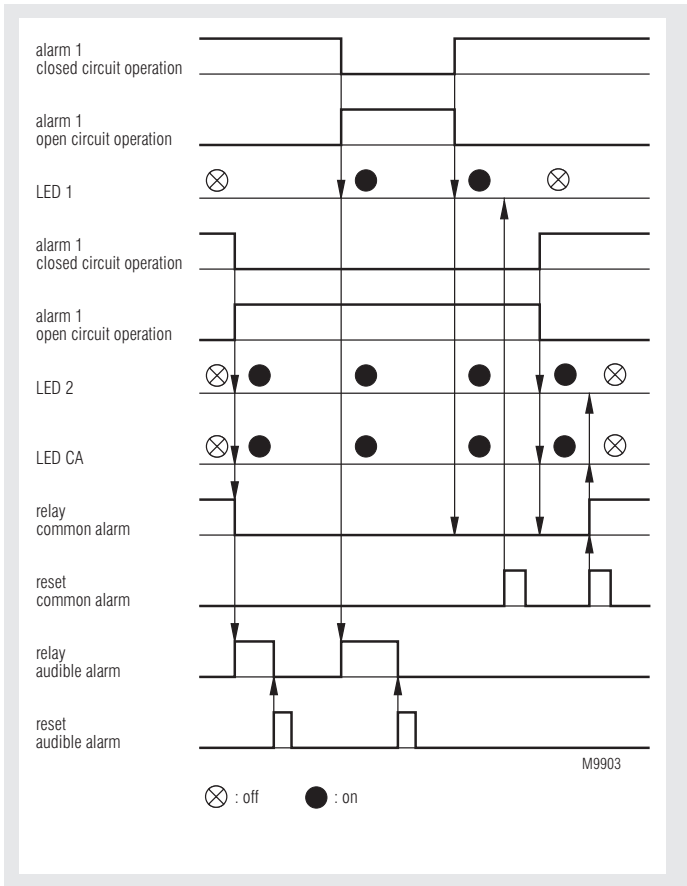

### Indication

LED green „ON“:	on when supply connected
LED red „CA“:	on when output common alarm active
LED yellow „BUS“:	on when bus active
LEDs red S1 ... S8	on when fault annunciator active

## Function Diagram (Faults with Auto Reset)

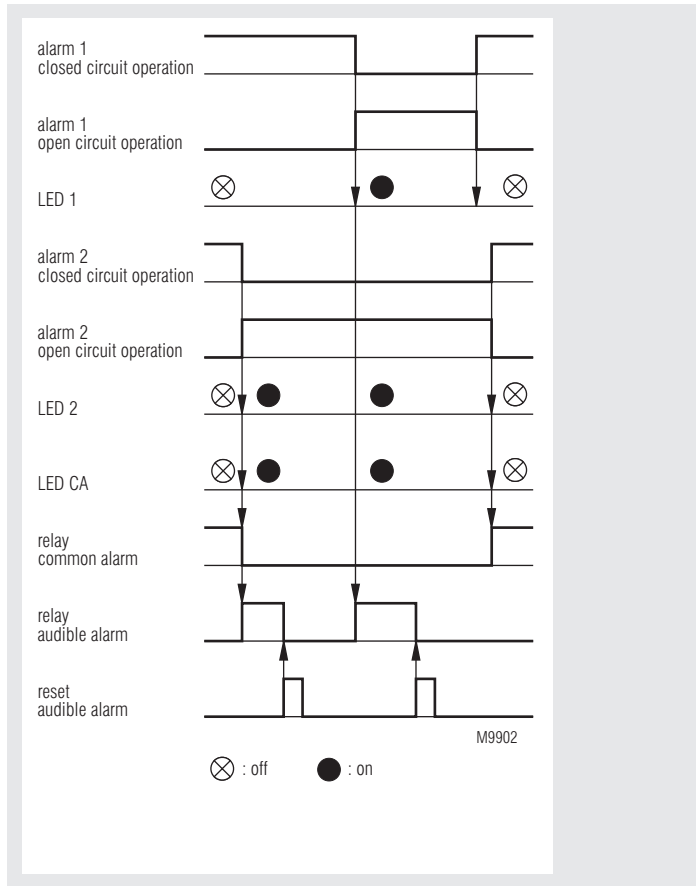

### Setting and Adjustment

#### Wiring

Devices with DC 24V auxiliary supply have to be operated on a galvanic separated power supply.

#### Configuration Cycle

- 1.) Wire the system
- 2.) Adjust module address on extension modules with switch "ADR" (different addresses for all modules)
- 2.1) When display units are integrated into the annunciator system the address setting of each display unit has to be done as follows
  - if the display unit should display the state of the base module (RP 5990) set "MODE" switch on back of the unit to position "Basismodul" and adjust an address that is not used by any other display unit.
  - if the display unit should display the state of an extension module (RP 5991) set "MODE" switch on back of the unit to position "Erw.modul" and adjust the same address as on the extension module (RP 5991) of which the status should be displayed.
- 3.) Set "MODE" switch on base module to position "Config"
- 4.) Choose input mode on extension modules:
  - Terminals X1/X2 open = open circuit operation
  - Terminals X1/X2 linked = closed circuit operation
- 5.) Set delay on switch, „td“ 0 ... 10 s
- 6.) Power up the system
- 7.) Fault signal LEDs of the base module are flashing for some time
- 8.) On the detected extension modules the fault signal LEDs are now flashing
- 9.) Fault signal LEDs change to continuous state and indicate number of detected extension modules in binary code
- 10.) The detected modules are stored no voltage safe in the base module memory. The fault annunciator only works with the detected modules. If a new module is added, the configuration cycle has to be run again.
- 11.) Select the required alarm function with switch "MODE" on the base module
- 12.) Press push buttons QH and QHC to leave the configuration mode.

## Setting and Adjustment

### Functions of Switch „MODE“





switch „MODE“	description
0	Common alarm annunciator alarm manual reset, inputs open circuit operation
1	Common alarm annunciator alarm auto reset, inputs open circuit operation
2	Common alarm annunciator alarm manual reset, inputs closed circuit operation
3	Common alarm annunciator alarm auto reset, inputs closed circuit operation
Configuration	Configuration

### Lamp Test

Pressing the pushbuttons QH and QCA simultaneously during normal operation will force a lamp test function (LT). During lamp test all fault signal LEDs are switched on.

### Fault Diagnostics

To indicate failures of the system the unit generates a flash code on the Bus LED. When a failure code 1 to 3 is displayed, the contacts of the common alarm relay switch off.

LED continuously on:	System has no failure
Failure 1  :	Configuration failure. One or more extension modules, that have been detected during configuration do not exist anymore. The address of the first missing extension module is displayed as binary code on the fault signal LEDs.
Failure 2  :	The base module cannot communicate with the extension modules. The address of the first extension module that cannot communicate with the base module is displayed as binary code on the fault signal LEDs.
Failure 3  :	The bus wire is interrupted or the bus is not terminated correctly. The base module does not find any extension modules to communicate with.
Failure 4  :	In normal operation: the configuration data has been found faulty. A new configuration cycles has to be run. During configuration: the detected configuration data could not be stored.
Failure 5  :	New modules unknown to the device software of the base module have to be implemented by a firmware update of the base module.

**Remark:** Different types of devices (device classes) can be connected to the annunciator bus e.g. extension modules RP 5990, display units EH 5990, EH 5991 etc. The base module detects the different module types and adds a device specific number to the adjusted bus module address (address offset). In the case of failure this added number is indicated as binary code on the LEDs of the base module.

Device class	address offset	modules
Extension modules	+ 0	RP 5991
Display unit	+ 10	EH 5990, EH 5991

## Technical Data

### Input

<b>Nominal voltage A1-A2:</b>	AC 230 V, DC 24 V
<b>Voltage range:</b>	0.8 ... 1.1 U <sub>N</sub>
<b>Nominal consumption A1-A2</b>	
at AC 230 V:	3.4 VA
at DC 24 V:	1.1 W
<b>Nominal frequency A1-A2</b>	
at AC 230 V:	50 Hz

### Fault Signal Inputs (only for RP 5990, RP 5991)

<b>Fault signal inputs S1...S8:</b>	AC/DC 24 ... 230 V
<b>Min. time for input signal:</b>	≥ 70 ms
<b>Min. time for acknowledgement:</b>	≥ 70 ms
<b>Operate delay</b>	setting with potentiometer 0 ... 10 s

### Output (only for RP 5990, RP 5991)

<b>Contacts:</b>	1 NO contact each for output common alarm and horn
<b>Thermal current I<sub>th</sub>:</b>	2 A
<b>Switching capacity</b>	
according to AC 15:	3 A / AC 230 V IEC/EN 60 947-5-1
<b>Electrical life</b>	
to AC 15 at 1 A, AC 230 V:	≥ 1.5 x 10 <sup>5</sup> sw. cycles IEC/EN 60 947-5-1
<b>Short circuit strength</b>	
<b>Max. fuse rating:</b>	4 A gL IEC/EN 60 947-5-1
<b>Mechanical life:</b>	≥ 30 x 10 <sup>6</sup> switching cycles

### RS485 Bus

RP 599_, EH 599_:	not isolated
RP 599_/1_ , EH 599/1_ :	isolated (1KV)
<b>Bus wire:</b>	screened twisted pair
<b>Data transmission rate:</b>	115.2 KB/s
<b>Attention: both ends of the twisted pair have to be terminated by inserting the links A/Ra and B/Rb!</b>	

### General Data

<b>Nominal operating mode:</b>	continuous operation
<b>Temperature range:</b>	- 20 ... + 55°C
<b>clearance and creepage distance</b>	
rated impuls voltage / pollution degree	
relay output:	4 kV / 2 IEC 60 664-1
input:	4 kV / 2 IEC 60 664-1
<b>EMC</b>	
Electrostatic discharge (ESD):	8 kV (air) IEC/EN 61 000-4-2
HF irradiation:	10 V / m IEC/EN 61 000-4-3
Fast transients:	2 kV IEC/EN 61 000-4-4
Surge voltage between	
wires for power supply:	1 kV IEC/EN 61 000-4-5
between wire and ground:	2 kV IEC/EN 61 000-4-5
Interference suppression:	Limit value class B EN 55 011
<b>Degree of protection RP 5990, RP 5991</b>	IEC/EN 60 529
Housing	
Cover:	IP 40
Base:	IP 30
Terminals:	IP 20
<b>Degree of protection EH 5990, EH 5991</b>	IEC/EN 60 529
Front:	IP 67
Enclosure:	IP 20
<b>Enclosure:</b>	thermoplastic with VO behaviour according to UL Subject 94
<b>Vibration resistance:</b>	0.35 mm amplitude, frequency 10 ... 55 Hz, IEC/EN 60 068-2-6
<b>Climate resistance:</b>	20 / 055 / 04 IEC/EN 60 068-1
<b>Terminal designation:</b>	EN 50 005

## Technical Data

<b>Wire connection</b>	DIN 46 228/1-/2-/3-/4
fixed screw terminal (S):	0.2 ... 4 mm <sup>2</sup> solid or 0.2 ... 1.5 mm <sup>2</sup> stranded wire with sleeve
plug-in screw terminal (PS):	0.1 ... 2.5 mm <sup>2</sup> solid or 0.1 ... 1.5 mm <sup>2</sup> stranded wire with sleeve
plug-in cage clamp terminals (PC):	0.2 ... 2.5 mm <sup>2</sup> solid or 0.2 ... 1.5 mm <sup>2</sup> stranded wire with sleeve

### Wire fixing

fixed screw terminals (S),  
plug-in screw terminals (PS): Captive plus-minus-terminal screws  
M2.5 with self raising terminal box

plug-in cage clamp terminals (PC): cage clamp terminals for directly  
plug-in of conductors  
Screwdriver 0.6 x 3.5 for removing  
of the cage-clamp

**Mounting:** DIN-rail IEC/EN 60 715

### Weight

RP 5990 S:	260 g
RP 5991 S:	240 g
EH 5990, EH 5991	
AC 230 V-version:	285 g
DC 24 V-version:	210 g

### Dimensions

#### Width x height x depth:

RP 5990, RP 5991:	70 x 90 x 71 mm
EH 5990, EH 5991:	96 x 96 x 60.5 mm

### Standard Types

RP 5990 S AC 230 V 50 Hz

Article number: 0059452

RP 5991 S AC 230 V 50 Hz

Article number: 0059456

- Nominal voltage  $U_N$ : AC 230 V
- fixed screw terminals
- Width: 70 mm

EH 5990 AC 230 V 50 Hz

Article number: 0060581

- Nominal voltage  $U_N$ : AC 230 V
- Reset buttons for audible alarm and common alarm on front side
- Width: 96 mm

EH 5991 AC 230 V 50 Hz

Article number: 0060585

- Nominal voltage  $U_N$ : AC 230 V
- Without reset buttons
- Width: 96 mm

### Ordering Example for RP 599\_

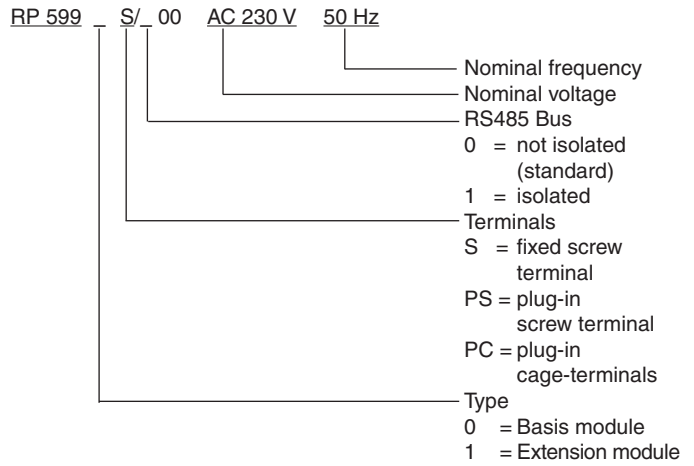

### Ordering Example for EH 599\_

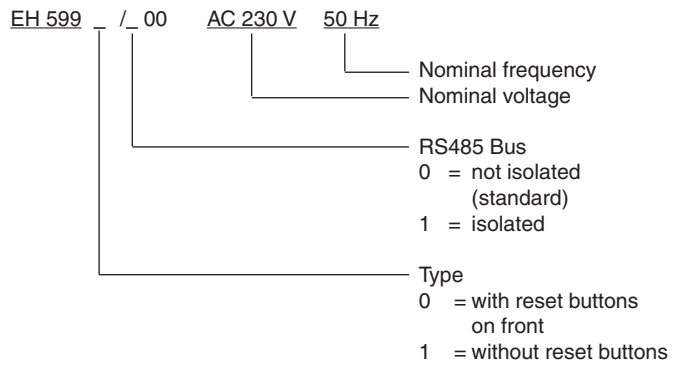

### Accessories

Buzzer RK 8832

# Connection Example

